

HYDAC

INTERNATIONAL

Up to max. 350 bar
Up to max. 120 l/min

**Valves and
Valve Combinations
for Flow Regulation**

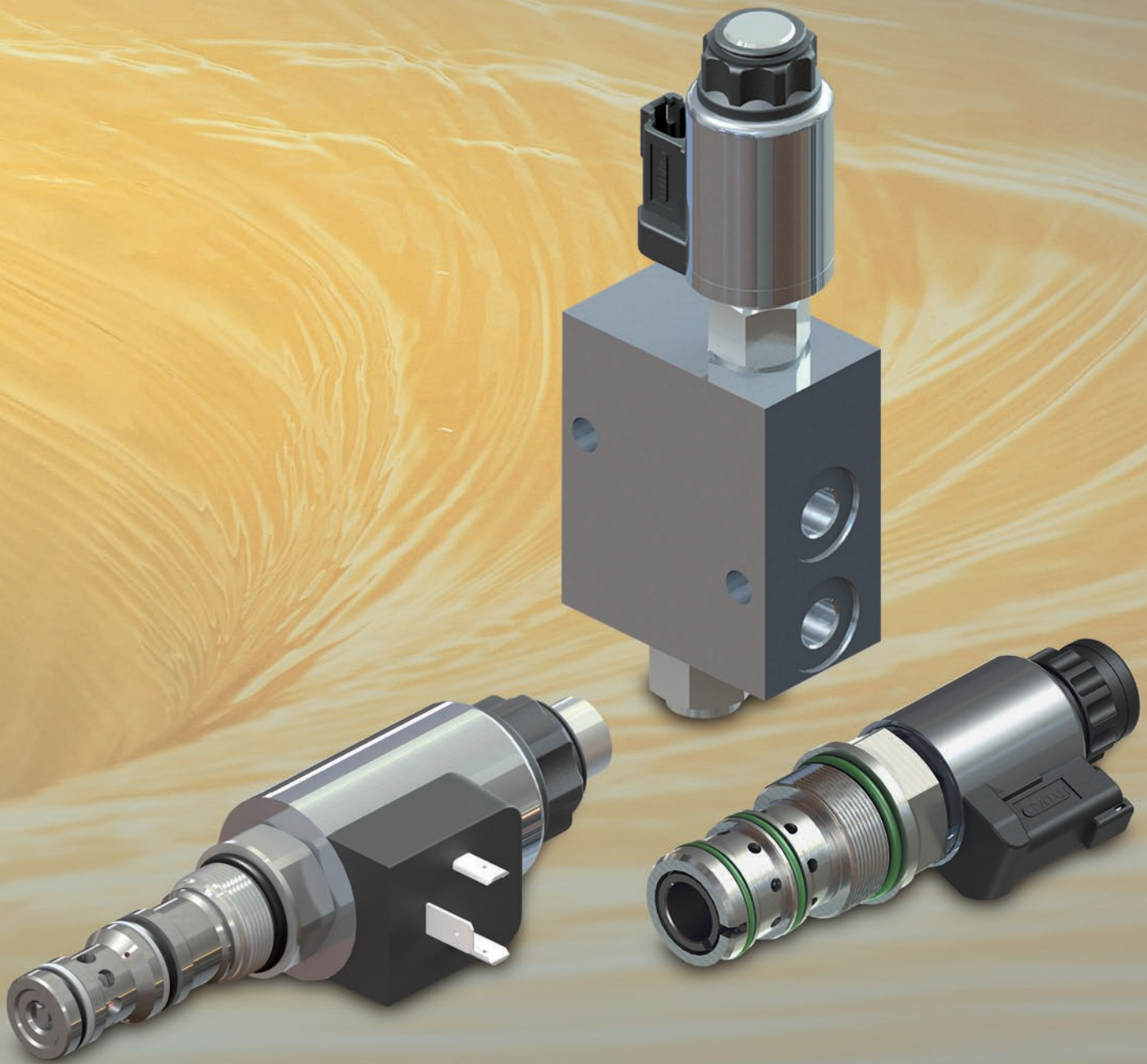

Optimum Speed Control for Enhanced Efficiency in Hydraulic Systems

Hydraulics can provide the highest power densities in drive technology. Modern switching and control technology considerably increases effectiveness and enhances efficiency in hydraulic systems.

Flow control combinations with separate or integrated pressure compensator make a significant contribution to reducing energy input in hydraulic systems.

The flow regulator is used for regulating steplessly the speed of motors and cylinders independently of the temperature and load. Independently of the load, the flow is constantly adjusted – a pressure compensator maintains the pressure differential by means of an orifice.

There are two versions: 2-way and 3-way flow regulators. In their most basic form, these are fixed orifices or manually adjustable needle valves in combination with a pressure compensator. Alternatively they are, as described below, combinations of electro-proportional, direct acting or pilot-operated control orifice adjustment and a pressure compensator.

Basic circuits in flow regulation:

1. Upstream flow regulation
2. Bypass spool-type flow regulation
3. Downstream flow regulation
4. Priority style flow regulation

Note

The information in this brochure relates to the operating conditions and applications described. For applications and/or operating conditions not described, please contact the relevant technical department.

Subject to technical modifications.

Our Technology

High resolution

Good damping – vibration resistant design

Simple LS port for solution with 2 cartridge valves

Robust – with simple and proven components

Additional options such as integrated pressure relief function or blocking with a screw

Long-lasting and safe operation

Your Advantages

- Exact and sensitive control of the application
- Increases availability due to control behaviour which does not damage the materials
- Can also easily be subsequently enhanced with an additional LS port
- Durable and reliable controls through proven valve technology
- Individual adaptability to customer solutions through the use of various valve constellations and options
- Resistant to contamination

1 Upstream Flow Regulation

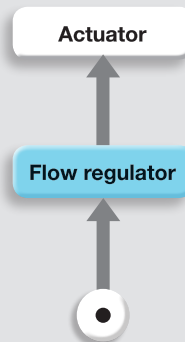

2 Bypass Spool-Type Flow Regulation

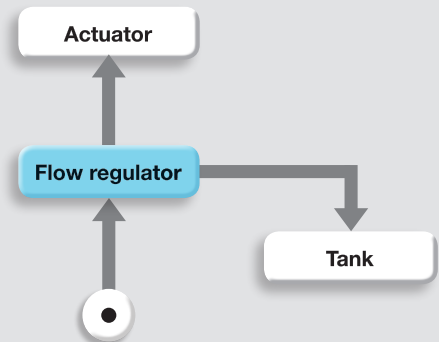

3 Downstream Flow Regulation

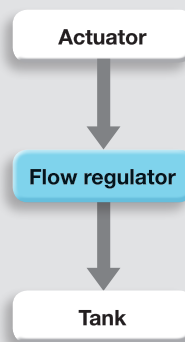

4 Priority Style Flow Regulation

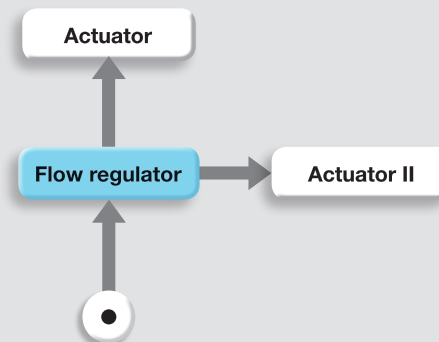

Flow Regulation as Tailored and Compact Solutions

Flow regulation with two cartridge valves: Needle valve and pressure compensator → Tailored solution

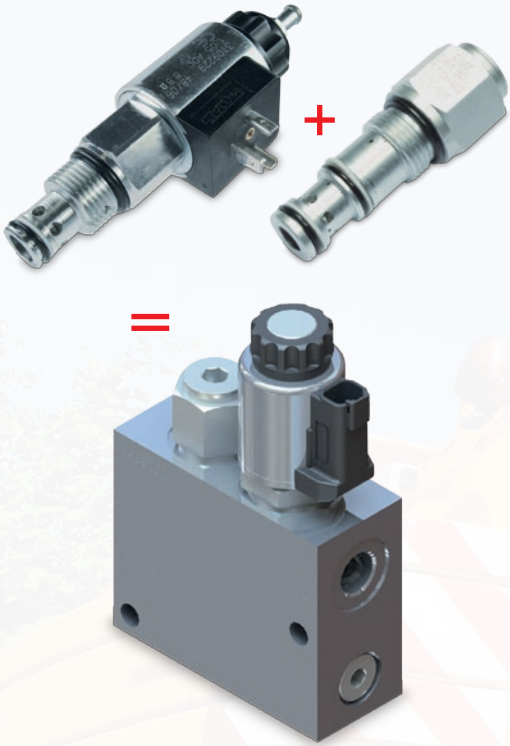

Flow regulation with one cartridge valve with integrated pressure compensator → Compact solution



HYDAC Modular System

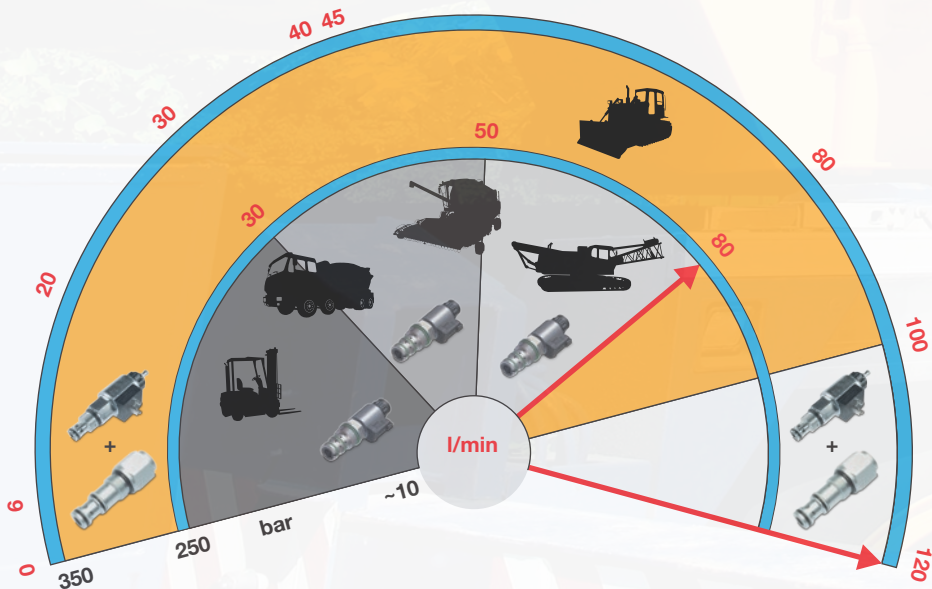

Basic Circuits in Flow Regulation with Needle Valve and Pressure Compensator

1



Solutions for Upstream Flow Regulation

2-way flow regulator with upstream pressure compensator. The upstream pressure compensator DW-V here is a direct-acting, spring-loaded needle valve in spool design with stepless control – normally open. By maintaining a constant pressure differential between the input and output pressure of the needle valve, a constant flow rate is maintained – independently of the load pressure. As soon as the pressure differential exceeds the value pre-set by the spring force, the control spool of the pressure compensator reduces an orifice cross-section and thus regulates the input pressure on the needle valve.

The upstream flow regulator can be used, for example, when **lifting** variable loads at the same velocity. The pressure compensator is positioned upstream of the consumer in order to react quickly to load changes. The load pressure acts directly on the pressure compensator.

The upstream pressure compensator is frequently used as an “individual pressure compensator” in “load-sensing” circuits with several consumers, each with different pressures. In parallel operation with several consumers, it prevents consumers with low load pressure from speeding ahead.

Note:

The orifice can be a fixed orifice, an adjustable needle valve or a proportional needle valve.

The circuit diagrams are purely symbolic.

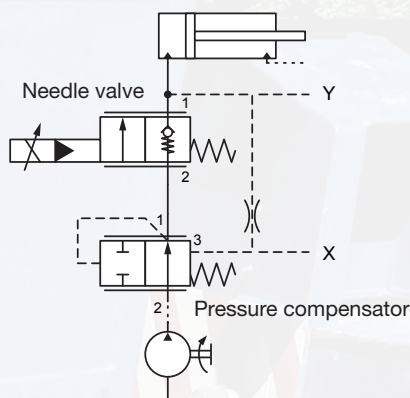

2

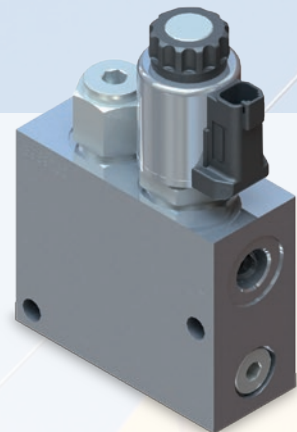

Solutions for Bypass Spool-Type Flow Regulation

3-way flow regulator with bypass spool-type pressure compensator and connected tank line. Depending on the pressure compensator, the pressure on the tank side can be increased almost to the pressure level of the consumer, although it must never exceed it. This makes it possible to use the residual flow rate in the tank line for an additional actuator. The bypass spool-type pressure compensator DW-Z here is a direct-acting, spring-loaded needle valve in spool design with stepless control – normally closed. By maintaining a constant differential between the input and output pressure of the needle valve, a constant flow rate is maintained – independently of the load pressure. As soon as the pressure differential exceeds the value pre-set by the spring force, the control spool opens an orifice cross-section and diverts the surplus flow which is not required by the consumer via a third port.

The bypass spool-type pressure compensator can be used, for example, when **lifting** variable loads at the same velocity. In general:

In “load-sensing” circuits, the bypass spool-type pressure compensator is often used as a “system-pressure compensator” where, if there is no demand from the consumer, the valve allows the oil to flow back to tank. This saves energy.

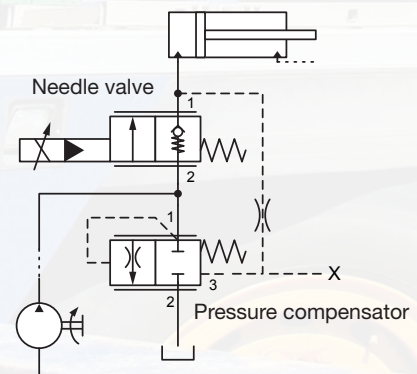

3

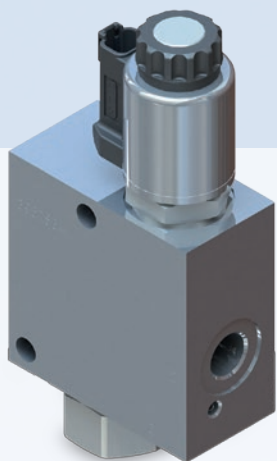

Solutions for Downstream Flow Regulation

2-way flow regulator with downstream pressure compensator and tank port. The downstream pressure compensator DW-R here is a direct-acting, spring-loaded needle valve in spool design with stepless control – normally open. By maintaining a constant differential between the input and output pressure of the needle valve, a constant flow rate is maintained – independently of the load pressure. As soon as the pressure differential exceeds the value pre-set by the spring force, the control spool reduces an orifice cross-section, thus regulating at the same time the output pressure on the needle valve.

The downstream pressure compensator can be used, for example, when **lowering** variable loads at the same velocity. By positioning the pressure compensator downstream of the consumer, there is good response sensitivity to changes in pressure. The pressure differential acts directly on the pressure compensator.

Preferred application in lift-lowering applications which use a plunger cylinder.

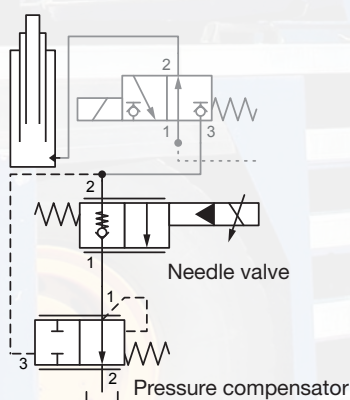

4

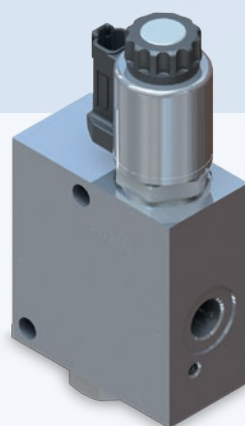

Solutions for Priority Style Flow Regulation

3-way priority style flow upstream regulation with connection of the secondary priority. The priority pressure compensator DW-P here is a direct-acting, spring-loaded valve in spool design with stepless control – normally open at port 1.

Its task is to supply port 1 as the first priority regardless of the load pressure (response port 4). If the pressure differential increases to overcome the spring force, the spool shifts to a throttle function at port 1 and begins to supply port 3 as the 2nd priority.

It is irrelevant to the function of the priority pressure compensator whether the pressure is higher at the first priority port 1 or at the 2nd priority port 3.

The priority pressure compensator can be used, for example, in steering control units to safeguard the steering when a vehicle is moving.

Note:

The orifice can be a fixed orifice, an adjustable needle valve or a proportional needle valve.

The circuit diagrams are purely symbolic.

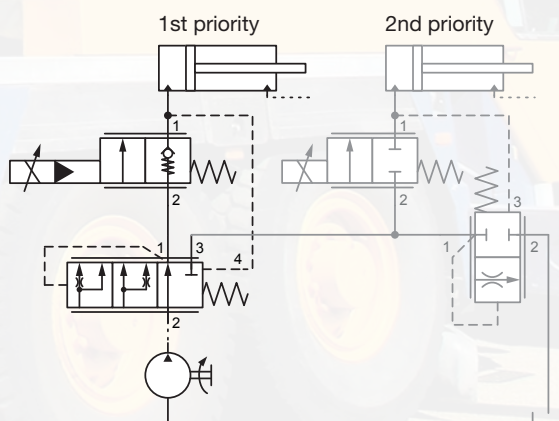

Flow Regulation with Two Cartridge Valves – Needle Valve and Pressure Compensator

1 Solutions for Upstream Flow Regulation

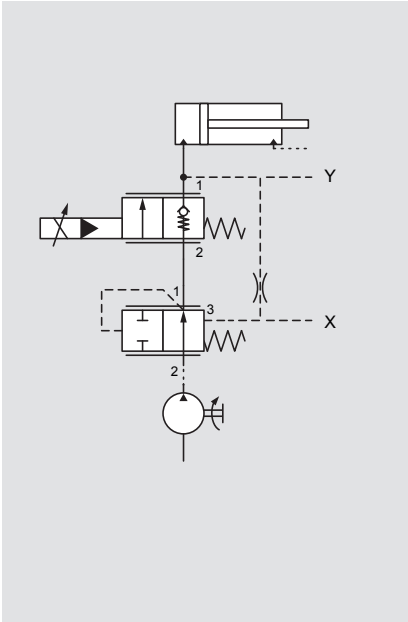

Application	Pressure compensator	Proportional needle valve	Q _{max} at 5 bar Δp / p _{max}
Lifting / driving loads with constant speed or e.g. as individual pressure compensator (responsible for one consumer) with several consumers in a single LS system.	DW05830V	PWK06020W and V	6 l/min / 350 bar
		EBS 4PWK06	5 l/min / 350 bar
	DW10V	PWS08Z	20 – 35 l/min / 350 bar
	EBS DW08V	PWK10120W and V	
		EBS 4PWKK10	25 l/min Q _{max} / 250 bar
		PWK12120W	45 l/min / 350 bar
DW16V	PWK12120WP	80 – 100 l/min / 280 bar	PWS16Z



2 Solutions for Bypass Spool-Type Flow Regulation

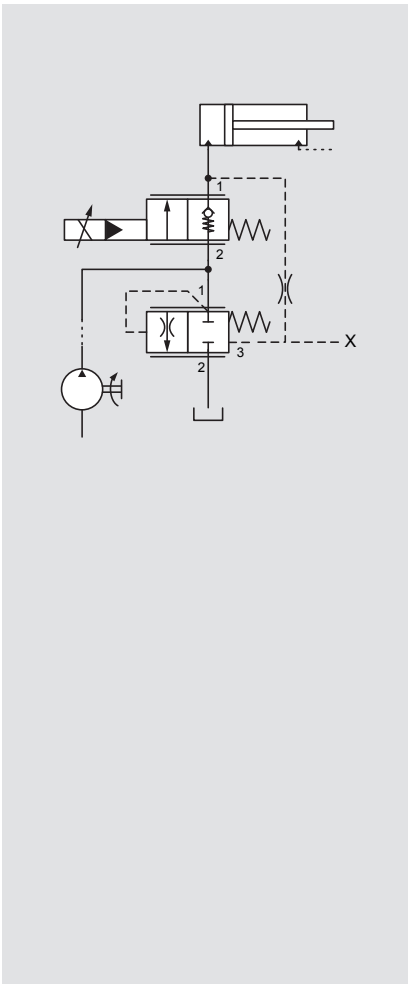

Application	Pressure compensator	Proportional needle valve	Q _{max} at 5 bar Δp / p _{max}
Load-sensing functions	DWM08130Z	PWK06020W and V	6 l/min / 250 bar
		PWS08Z	20 l – 35 l/min / 250 bar
When used with several consumers, the bypass spool-type pressure compensator acts as a system pressure compensator in the LS system.		EBS 4PWK06	5 l/min / 250 bar
	DW10Z	PWK10120W and V	30 – 40 l/min / 250 bar
		EBS 4PWKK10	25 l/min Q _{max} / 50 bar
		PWK12120W	45 l/min / 250 bar
	DWM12121Z	PWK10120W and V	30 l/min / 250 bar
	WM12130Z	EBS 4PWKK10	25 l/min Q _{max} / 250 bar
	DB12121PE		
	DWM12121ZD	PWK12120W	45 l/min / 250 bar
	DWM12121ZM D(Z)	PWK12120WP	100 l/min / 250 bar
		PWS10Z	40 l/min / 250 bar
	PWS16Z	100 – 120 l/min / 250 bar	
DW16Z	PWK12120WP	100 l/min / 280 bar	
DB16221PE	PWS10Z	40 l/min / 250 bar	
DB16621E			
DB12121PE	PWS16Z	80 l/min / 250 bar	



at a Glance

3 Solutions for Downstream Flow Regulation

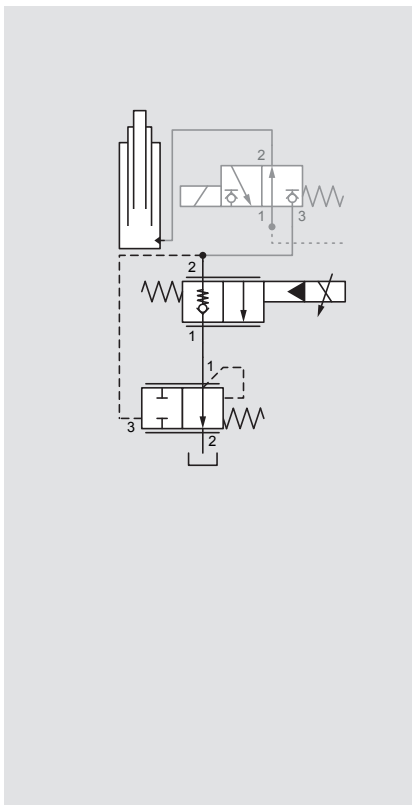

Application	Pressure compensator	Proportional needle valve	Q _{max} at 5 bar Δp / p _{max}
Lift / lower functions	DWM08130Y	PWK06020W and V	6 l/min / 250 bar
Lowering of loads with constant speed, typical for forklift applications		PWS08Z	20 l/min / 250 bar
	DWM10130R DWM12130Y	PWS10Z PWK10120W and V	40 – 70 l/min / 250 bar
	DWM12130R DWM12130Y	PWK12120W	45 l/min / 250 bar
	DWM12130R DWM12130Y	PWS16Z PWK12120WP	80 – 100 l/min / 250 bar

For lowering applications in the usual flow rate range up to approx. 60 l/min.

- Many versions available within the PWS series, various characteristic curves – linear, progressive, hyper-progressive
- Adjustable maximum flow limitation
- Adjustable opening point setting
- Soft-shift possible



4 Solutions for Priority Style Flow Regulation

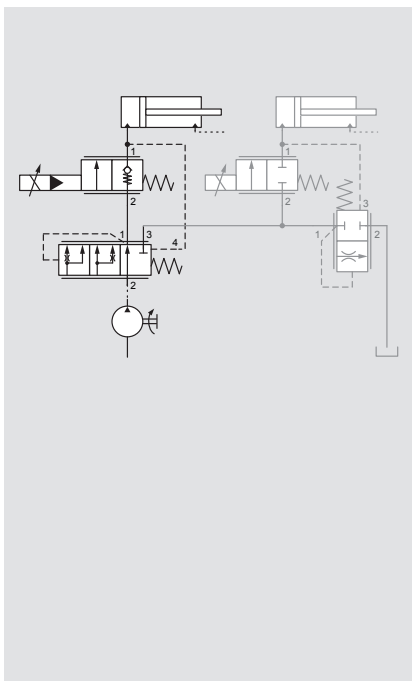

Application	Pressure compensator	Proportional needle valve	Q _{max} at 5 bar Δp / p _{max}
Priority valve	DW12P	PWK12120W	45 l/min / 250 bar
Steering	DW12P	PWS16Z	80 l/min / 250 bar
Supply of more than one consumer	DW12P	PWK12120WP	100 l/min / 250 bar

Note: Combinations marked in red are available as standard manifolds. The application descriptions and circuit diagrams are purely symbolic. When considering an actual application, please refer to the individual valve documentation.

1 Solutions for Upstream Flow Regulation

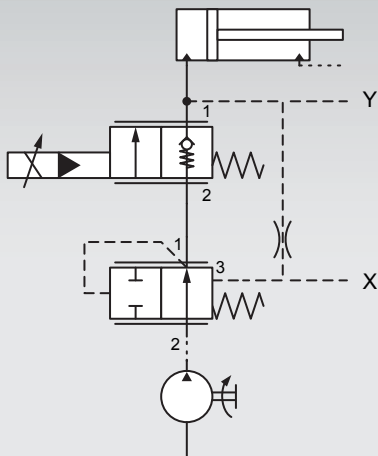

2-way proportional flow regulator B-BM-STRZ

Application example

Load-independent speed control for rotary drives – in this case the reel in a combine harvester.

Solution

2-way proportional flow regulator with separate pressure compensator and proportional needle valve in the control block. This controls the quantity of oil for the hydraulic motor. If the resistance increases through alteration of the cutting parameters (e.g. thicker plants, denser growth) and with it the torque of the hydraulic motor, the reel would rotate more slowly without the flow regulation function and the cutting performance would be reduced – because the Δp across the needle valve decreases when at a constant pressure supply. The 2-way flow regulator maintains the Δp across the orifice via the pressure compensating function and at the same time the flow, thus resulting in a load-independent, constant motor speed.

If an adjustable needle valve is selected, then it can also be used to vary the speed of the drive independently of the load. This makes it possible, for example, to couple the vehicle speed to the cutting speed, thus leading to an automatic speed adjustment of the reel. HYDAC offers, depending on the flow required, two standard solutions that implement the optimum adjustment to the exact requirements.

Port Y

Coupling to existing LS system possible

Port X

Port X is normally closed. For the individual pressure reduction in an LS system there is the option to install a small pressure relief valve here. There is only a small flow to the tank in this case. In terms of energy consumption, this is a reasonable method for the individual pressure protection of the consumer.

Application	Pressure compensator	Proportional needle valve	Q _{max} at 5 bar Δp / p _{max}	Proportional flow regulator
Lifting / driving loads with constant speed or e.g. as individual pressure compensator	DW05830V	PWK06020W and V	6 l/min / 350 bar	
		EBS 4PWK06	5 l/min / 350 bar	
(responsible for one consumer) with several consumers in a single LS system.	DW10V	PWS08Z	20 – 35 l/min / 350 bar	B-BM-STRZ-35-350
	EBS DW08V	PWK10120W and V		
		EBS 4PWKK10	25 l/min Q _{max} / 250 bar	
		PWK12120W	45 l/min / 350 bar	
	DW16V	PWK12120WP PWS16Z	80 – 100 l/min / 280 bar	B-BM-STRZ-100-280

Note: Combinations marked in red are available as standard manifolds. The application descriptions and circuit diagrams are purely symbolic. When considering an actual application, please refer to the individual valve documentation.

Valve technology

Function PWS08Z / PWS16Z

Proportional flow controllers in the PWS...Z series are pilot-operated, normally closed, spring-loaded, poppet-type flow control valves.

They are non-compensated and their function is to smoothly control the flow from port 2 to port 1.

The main spool opens, depending on the energization of the coil.

- Operating pressure: max. 350 bar
- Flow rate: max. 55 / 200 l/min
- Internal leakage: leakage oil-free
- Cavity: FC10-2 / FC16-2
- Weight: 0.5 kg / 0.9 kg

Electronic controls

In order to control the proportional valves in the control block, suitable electronics are required to provide the correct power.

HYDAC offers a wide variety of basic models in the mobile range:

From the simple amplifier module to the complete mobile control HY-TTC 30 – 580.

Amplifier module

Technical data

- Analogue inputs: 0 – 10 V / 0 – 20 mA
- Control current: 0 – 3,000 mA;
(12 / 24 V)
- Supply voltage: 9 – 32 V
- Interface: CAN Bus
- Dither frequency: 330 Hz
- Ramp function: Yes, 0 – 10 sec.
- Adjustment parameters via potentiometer for MIN, MAX and RAMP
- Internal digital structure for signal processing
- Hardware protective circuit for short-circuit monitoring
- Can be configured via DIL buttons

In preparation

Function DW10V / DW16V

Pressure compensators in the series DW10V / DW16V-01 are direct-acting, spring-loaded flow control valves in spool design with smooth control – normally open.

By maintaining a constant differential between the input and output pressure, e.g. of an orifice (ports 1 and 3 of the pressure compensator), a constant flow rate is maintained – independently of the load pressure.

As soon as the pressure differential exceeds the value pre-set by the spring force, the control spool reduces an orifice cross-section.

- Operating pressure: max. 350 bar
- Flow rate: max. 57 / 120 l/min
- Cavity: FC10-2 / FC16-2
- Weight: 0.16 kg / 0.32 kg

Mobile control



HY-TTC30 → HY-TTC580

8 – 36 PWM outputs, from CAN-Bus, RS232, LIN to USB

Technical data HY-TTC30

- Controller: Infineon XC22xx Microcontroller
- Memory: 768 kB Flash, 82 kB RAM
- Analogue inputs: 10 – 5 V / 0 – 10 V / 0 – 25 mA
- PWM outputs: 8 high-side (6 with current measurement)
- Digital outputs: 2 low-side
- Control current: 800 mA; 19.2 Ohm (24 V)
1,600 mA; 5.0 Ohm (12 V)
- Supply voltage: 8 – 32 V
- Interface: CAN Bus
- Dither frequency: 100 – 250 Hz

See Catalogue 18.500

2 Solutions for Bypass Spool-Type Flow Regulation

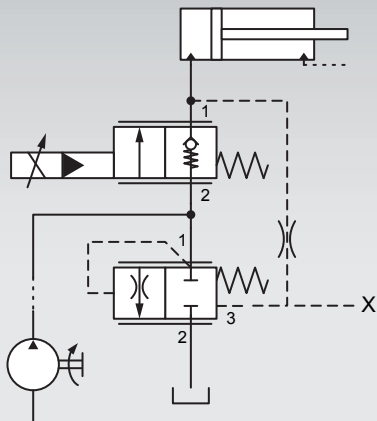

3-way proportional flow regulator B-BM-STRU

Application example

3-way flow regulator, hydraulically or proportionally controlled, as closed system for one consumer.

Solution

The 3-way flow regulator can supply a single consumer as an autonomous, closed system. An additional consumer can also be supplied, under the condition that the pressure level at the tank pressure port is always lower than the pressure level of the consumer port. The pressure compensator can be optionally supplied with an integrated pressure relief function, internal relief and blocking of the control function (for variable pumps).

In general, circuits with a bypass spool-type pressure compensator and a needle valve are used to provide the oil quantity according to requirements and independently of load and to discharge a residual oil volume to the tank with low pressure loss.

HYDAC offers the specific module for this purpose.

Port X

Port X is normally closed. By adding a small pressure relief valve, the bypass spool-type pressure compensator can take over the maximum pressure relief function as well.

Application	Pressure compensator	Proportional needle valve	Q _{max} at 5 bar Δp / p _{max}	Proportional flow regulator
Load-sensing functions	DWM08130Z	PWK06020W and V	6 l/min / 250 bar	
When used with several consumers, the bypass spool-type pressure compensator acts as a system pressure compensator in the LS system.		PWS08Z	20 – 35 l/min / 250 bar	B-BM-STRU-35-250
		EBS 4PWK06	5 l/min / 250 bar	
	DW10Z	PWK10120W and V	30 – 40 l/min / 250 bar	
		EBS 4PWKK10	25 l/min Q _{max} / 50 bar	
		PWK12120W	45 l/min / 250 bar	
	DWM12121Z	PWK10120W and V	30 l/min / 250 bar	
	WM12130Z			
	DB12121PE	EBS 4PWKK10	25 l/min Q _{max} / 250 bar	
	DWM12121ZD	PWK12120W	45 l/min / 250 bar	
	DWM12121ZM D(Z)	PWK12120WP	100 l/min / 250 bar	
	PWS10Z	40 l/min / 250 bar		
	PWS16Z	100 – 120 l/min / 250 bar	B-BM-STRU-100-250	
DW16Z	PWK12120WP	100 l/min / 280 bar		
DB16221PE	PWS10Z	40 l/min / 250 bar		
DB16621E	PWS16Z	80 l/min / 250 bar		
DB12121PE				

Note: Combinations marked in red are available as standard manifolds. The application descriptions and circuit diagrams are purely symbolic. When considering an actual application, please refer to the individual valve documentation.

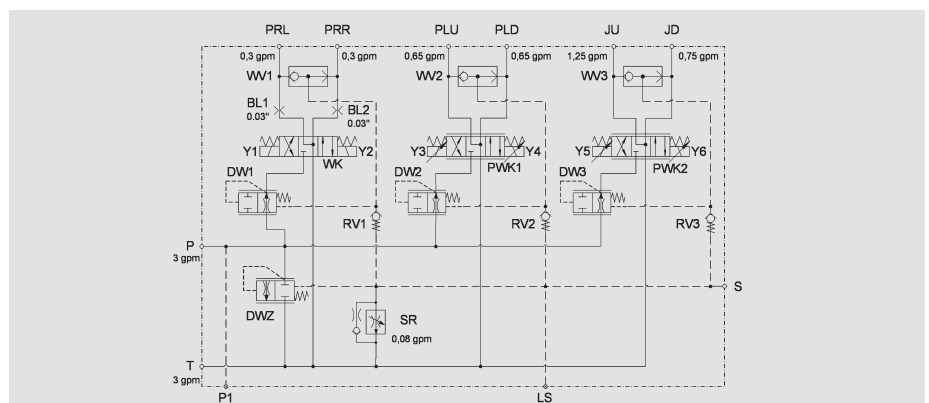

Valve technology

Function PWS08Z / PWS16Z

Proportional flow controllers in the PWS...Z series are pilot-operated, normally closed, spring-loaded, poppet-type flow control valves.

They are non-compensated and their function is to smoothly control the flow from port 2 to port 1.

The main spool opens, depending on the energization of the coil.

- Operating pressure: max. 350 bar
- Flow rate: max. 55 / 200 l/min
- Internal leakage: leakage oil-free
- Cavity: FC10-2 / FC16-2
- Weight: 0.5 kg / 0.9 kg

Electronic controls

In order to control the proportional valves in the control block, suitable electronics are required to provide the correct power.

HYDAC offers a wide variety of basic models in the mobile range:

From the simple amplifier module to the complete mobile control HY-TTC 30 – 580.

Amplifier module

Technical data

- Analogue inputs: 0 – 10 V / 0 – 20 mA
- Control current: 0 – 3,000 mA;
(12 / 24 V)
- Supply voltage: 9 – 32 V
- Interface: CAN Bus
- Dither frequency: 330 Hz
- Ramp function: Yes, 0 – 10 sec.
- Adjustment parameters via potentiometer for MIN, MAX and RAMP
- Internal digital structure for signal processing
- Hardware protective circuit for short-circuit monitoring
- Can be configured via DIL buttons

In preparation

Function DWM08130Z / DWM12121Z

Pressure compensators in the series DWM08130 and 12121Z are direct-acting, spring-loaded flow control valves in spool design with smooth control – normally closed.

By maintaining a constant differential between the input and output pressure, e.g. of an orifice (ports 1 and 3 of the pressure compensator), a constant flow rate is maintained – independently of the load pressure.

As soon as the pressure differential exceeds the value pre-set by the spring force, the control spool opens an orifice cross-section and diverts the surplus flow which is not required by the consumer via a third port.

- Operating pressure: max. 250 / 350 bar
- Flow rate: max. 40 / 120 l/min
- Cavity: 08130 / 12121
- Weight: 0.15 kg / 0.5 kg

Pump pressure = load pressure + spring offset
(approx. 5 to 15 bar)

Option: Maximum pressure reduction can be switched off

Mobile control



HY-TTC30 → HY-TTC580

8 – 36 PWM outputs, from CAN-Bus, RS232, LIN to USB

Technical data HY-TTC30

- Controller: Infineon XC22xx Microcontroller
- Memory: 768 kB Flash, 82 kB RAM
- Analogue inputs: 10 – 5 V / 0 – 10 V / 0 – 25 mA
- PWM outputs: 8 high-side (6 with current measurement)
- Digital outputs: 2 low-side
- Control current: 800 mA; 19.2 Ohm (24 V)
1,600 mA; 5.0 Ohm (12 V)
- Supply voltage: 8 – 32 V
- Interface: CAN Bus
- Dither frequency: 100 – 250 Hz

See Catalogue 18.500

3 Solutions for Downstream Flow Regulation

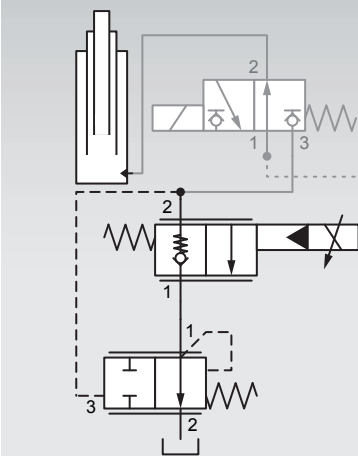

2-way proportional flow regulator B-BM-STRA

Application example

Load-independent speed control when lowering variable loads.
Preferred application in lift-lowering applications which use a plunger cylinder.

Solution

2-way flow regulator with pressure compensator and orifice downstream of the consumer. The requirement for consistent lift/lowering speed with variable loads, e.g. of a plunger cylinder in stacker trucks, is achieved with this circuit.

By positioning the pressure compensator downstream of the consumer, there is good response sensitivity to changes in pressure, as the pressure compensator is directly aligned with the consumer and can thus react immediately to pressure fluctuations. The pressure differential acts directly on the pressure compensator, thus making the system less susceptible to oscillations.

Application	Pressure compensator	Proportional needle valve	Q _{max} at 5 bar Δp / p _{max}	Proportional flow regulator
Lifting / lowering functions	DWM08130Y	PWK06020W and V	6 l/min / 250 bar	
Lowering of loads with constant speed, typical for forklift applications		PWS08Z	20 l/min / 250 bar	
	DWM10130R DWM12130Y	PWS10Z PWK10120W and V	40 – 70 l/min / 250 bar	B-BM-STRA-70-250
	DWM12130R DWM12130Y	PWK12120W	45 l/min / 250 bar	
	DWM12130R DWM12130Y	PWS16Z PWK12120WP	80 – 100 l/min / 250 bar	B-BM-STRA-100-250

Note: Combinations marked in red are available as standard manifolds.
The application descriptions and circuit diagrams are purely symbolic.
When considering an actual application, please refer to the individual valve documentation.

Valve technology

Function PWS10Z / PWS16Z

Proportional flow controllers in the PWS...Z series are pilot-operated, normally closed, spring-loaded, poppet-type flow control valves.

They are non-compensated and their function is to smoothly control the flow from port 2 to port 1.

The main spool opens, depending on the energization of the coil. The P-I graph has a progressive characteristic and is therefore particularly well-suited for lift-lowering applications because a particularly sensitive control is possible with a low lowering speed.

- Operating pressure: max. 350 bar
- Flow rate: max. 60 / 120 l/min
- Internal leakage: leakage oil-free
- Cavity: FC16-2
- Weight: 0.5 kg / 0.9 kg

Electronic controls

In order to control the proportional valves in the control block, suitable electronics are required to provide the correct power.

HYDAC offers a wide variety of basic models in the mobile range:

From the simple amplifier module to the complete mobile control HY-TTC 30 – 580.

Amplifier module

Technical data

- Analogue inputs: 0 – 10 V / 0 – 20 mA
- Control current: 0 – 3,000 mA;
(12 / 24 V)
- Supply voltage: 9 – 32 V
- Interface: CAN Bus
- Dither frequency: 330 Hz
- Ramp function: Yes, 0 – 10 sec.
- Adjustment parameters via potentiometer for MIN, MAX and RAMP
- Internal digital structure for signal processing
- Hardware protective circuit for short-circuit monitoring
- Can be configured via DIL buttons

In preparation

Function DWM10130R / DWM12130R

Pressure compensators in the series DWM10130 and 12130R are direct-acting, spring-loaded flow control valves – normally open.

By maintaining a constant differential between the input and output pressure, e.g. of an orifice (ports 3 and 1 of the pressure compensator), a constant flow rate is maintained – independently of the load pressure.

As soon as the pressure differential exceeds the value pre-set by the spring force, the control spool reduces an orifice cross-section.

- Operating pressure: max. 250 / 350 bar
- Flow rate: max. 60 / 150 l/min
- Cavity: 10130 / 12130
- Weight: 0.9 kg / 1.1 kg

Mobile control



HY-TTC30 → HY-TTC580

8 – 36 PWM outputs, from CAN-Bus, RS232, LIN to USB

Technical data HY-TTC30

- Controller: Infineon XC22xx Microcontroller
- Memory: 768 kB Flash, 82 kB RAM
- Analogue inputs: 10 – 5 V / 0 – 10 V / 0 – 25 mA
- PWM outputs: 8 high-side (6 with current measurement)
- Digital outputs: 2 low-side
- Control current: 800 mA; 19.2 Ohm (24 V)
1,600 mA; 5.0 Ohm (12 V)
- Supply voltage: 8 – 32 V
- Interface: CAN Bus
- Dither frequency: 100 – 250 Hz

See Catalogue 18.500

4 Solutions for Priority Style Flow Regulation

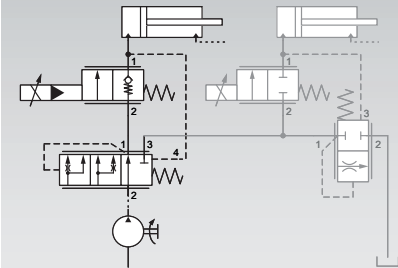

3-way proportional flow regulator B-BM-STRP

Application example

To supply a subsystem as the first priority regardless of the load pressure and then to supply the non-priority work circuit.

Solution

3-way proportional flow regulator with separate priority pressure compensator and proportional needle valve for prioritized supply to a subsystem, i.e. various functions that are supplied with a fixed oil flow. The remaining functions are supplied with the residual flow, or for larger outputs by the pump. Bypass spool-type pressure compensator with separate proportional needle valve in the control block.

Supply of the first priority functions is guaranteed by the pressure compensator DWP12 – the residual oil can be made available for the working hydraulics of the machine or flows to the tank. If the pressure at port 3 (2nd priority) of the priority pressure compensator increases due to increased load, then the oil quantity for the 1st priority will nevertheless be maintained, independently of the load.

It is completely irrelevant to the function of this circuit whether the pressure is higher at the first priority or secondary priority. The priority pressure compensator has an orifice at the 1st and 2nd priority.

The proportional needle valve is replaced by the steering orbitrol in driving applications.

Application	Pressure compensator	Proportional needle valve	Q _{max} at 5 bar Δp / p _{max}	Proportional flow regulator
Priority valve	DW12P	PWK12120W	45 l/min / 250 bar	
Steering	DW12P	PWS16Z	80 l/min / 250 bar	B-BM-STRP-80-250
Supply of more than one consumer	DW12P	PWK12120WP	100 l/min / 250 bar	

Note: Combinations marked in red are available as standard manifolds. The application descriptions and circuit diagrams are purely symbolic. When considering an actual application, please refer to the individual valve documentation.

Valve technology

Function PWS16Z

Proportional flow controllers in the PWS16Z series are pilot-operated, normally closed, spring-loaded, poppet-type flow control valves.

They are non-compensated and their function is to smoothly control the flow from port 2 to port 1.

The main spool opens, depending on the energization of the coil.

- Operating pressure: max. 350 bar
- Flow rate: max. 120 l/min
- Internal leakage: leakage oil-free
- Cavity: FC16-2
- Weight: 0.9 kg

Electronic controls

In order to control the proportional valves in the control block, suitable electronics are required to provide the correct power.

HYDAC offers a wide variety of basic models in the mobile range:

From the simple amplifier module to the complete mobile control HY-TTC 30 – 580.

Amplifier module

Technical data

- Analogue inputs: 0 – 10 V / 0 – 20 mA
- Control current: 0 – 3,000 mA;
(12 / 24 V)
- Supply voltage: 9 – 32 V
- Interface: CAN Bus
- Dither frequency: 330 Hz
- Ramp function: Yes, 0 – 10 sec.
- Adjustment parameters via potentiometer for MIN, MAX and RAMP
- Internal digital structure for signal processing
- Hardware protective circuit for short-circuit monitoring
- Can be configured via DIL buttons

In preparation

Function DW12P

The priority pressure compensator DW12P is a direct-acting, spring-loaded, smooth-operating spool valve.

It is normally open at service port 1 and is supplied by pump port 2. Its task is to supply port 1 as the first priority regardless of the load pressure (port 4). If the pressure differential increases to overcome the spring force, the spool shifts to a throttle function at port 1 and begins to supply port 3 as the 2nd priority. The priority pressure compensator can, for example, be used in steering control units to safeguard the steering when a vehicle is moving.

- Operating pressure: max. 350 bar
- Flow rate: max. 100 l/min
- Cavity: FC12-4
- Weight: 0.4 kg

Option: Dynamic pressure tapping via integrated orifice.
Advantage: Flushes the LS line or heats up the oil.
The connected steering system reacts more rapidly as a result.

Mobile control



HY-TTC30 → HY-TTC580

8 – 36 PWM outputs, from CAN-Bus, RS232, LIN to USB

Technical data HY-TTC30

- Controller: Infineon XC22xx Microcontroller
- Memory: 768 kB Flash, 82 kB RAM
- Analogue inputs: 10 – 5 V / 0 – 10 V / 0 – 25 mA
- PWM outputs: 8 high-side (6 with current measurement)
- Digital outputs: 2 low-side
- Control current: 800 mA; 19.2 Ohm (24 V)
1,600 mA; 5.0 Ohm (12 V)
- Supply voltage: 8 – 32 V
- Interface: CAN Bus
- Dither frequency: 100 – 250 Hz

See Catalogue 18.500

Flow Regulation using One Cartridge Valve with Integrated Pressure Compensator



Proportional flow regulator PSRPM20330

Up to 350 bar, up to 100 l/min

Application example

Load-independent speed control for several rotary drives with common pressure supply – in this case worm, distributing plate, damp salt pump drives.

General

This regulator can be used to create cost-efficient position controls without actual value responses as well as precise, closed control circuits. Installation in customized housings as 2-way or 3-way regulators is possible.

- Exact adjustment of the flow by selecting different orifices
- Energy-efficient design to meet the exact customer requirement
- Various actuation types optionally available: Proportional, proportional with handwheel, only handwheel scale knob: one rotation with limiter, both scales with adjustable index – fits very easily in the hand
- Stable control behaviour (oscillation-resistant) through variable absorption across the entire flow rate range
- Wide flow control range (from 4 to 80 l/min)
- Residual flow load capacity: it is completely irrelevant to the function of the valve whether the pressure is higher at the first or the secondary priority
- Service-friendliness (pressure compensator and metering orifice on a single axis)
- Low hysteresis and small Δp
- Load-sensing capability
- Thanks to ZnNi coating and internal seal, also suitable for difficult / demanding conditions – totally suitable for mobile applications

Function

The PSRPM20330 is a proportional 3-way priority style flow control valve that regulates the flow rate via a variable orifice cross-section.

Depending on the control current, the flow rate is regulated at port 3. Excess oil is discharged at port 2.

A pressure drop is produced by the flow rate supply at port 1 via a metering orifice. The cross-section of this metering orifice can be adjusted proportionally, independently of pressure. The higher the control current, the larger the cross-section.

The pressures upstream and downstream from the metering orifice balance a pre-tensioned pressure compensator spool that opens changing cross-sections at the outlet of the valve, depending on the stroke (control orifice). This means that the pressure compensator spool maintains the level of the pressure drop via the metering orifice and maintains a constant flow to port 3, irrespective of the pressure differential. Excess oil that is supplied to the valve at port 1 initially builds up and increases the pressure. With increasing pressure differential from 1 to 3, the pressure compensator spool reduces the cross-section at the control orifice and at the same time opens a bypass from port 1 to 2 in order to discharge the excess oil. The excess oil is made available to other consumers at port 2.

Optional: The flow range of the valve can be adjusted through the use of various metering orifices.

Types of actuation:

1. Electro-proportional actuation
2. Electro-proportional actuation and additional handwheel
3. Handwheel

Typical applications

Rotary drives, e.g. for:

- **Municipal and road construction**
Sweepers (brushes), sewer cleaning vehicles (reel), winter road maintenance (worms, plates, wet salt), pavers (worms), road maintenance equipment (belts), garbage trucks (flow rate control), municipal vehicles / equipment carriers (equipment supply)
- **Agriculture and forestry**
Small tractors (equipment supply), feed mixing vehicles, grape harvesters, potato harvesters (belts), spreaders (artificial fertilizers), loading vehicles/fertilizer spreaders (scraper floors), sugar beet harvesters (star screens, belts), forestry equipment (winches)
- **Lifting technology**
Forklift/mast carriages (lifting gear)

Electronics

- Control current: 800 mA; 19.2 Ohm (24 V)
1,600 mA; 5.0 Ohm (12 V)
- Dither frequency: 100 – 160 Hz
- Hysteresis with dither: 5 % at I_{nom}
- Repeat accuracy: ≤ 1.5 % of the maximum pressure range
- Reversal error: ≤ 2.0 % of the max. control current
- Response sensitivity: ≤ 1.0 % of the max. control current
- Coil type: Coil...-50-2345

Function

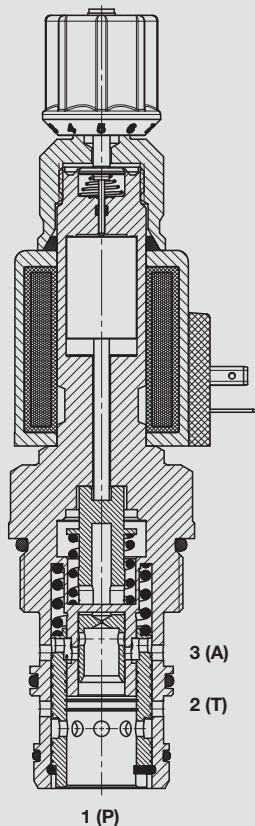

Specifications

- Operating pressure: max. 350 bar
- Flow rate: max. 100 l/min
(control range 80 l/min)
- Media operating temperature range: -20 °C to max. +100 °C
- Ambient temperature range: -20 °C to max. +60 °C
- Operating fluid: Hydraulic oil in accordance with DIN 51524, Parts 1 and 2
- Viscosity range: 10 – 420 mm²/s is recommended
- Filtration: ISO 4406 Class 19/17/14
- MTTFd: 150 years
- Installation position: no orientation restrictions
- Cavity: metric 20330
- Materials: Valve body: machining steel, Spool: hardened, ground steel
Seals: NBR (Standard)
FKM (Optional)
- Coil: Steel / polyamide
- Weight: 1.3 kg

Performance

Measured at 42 mm²/s and $T_{oil} = +50$ °C

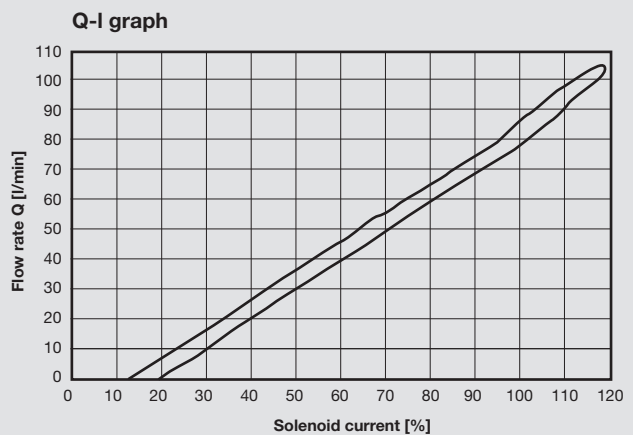
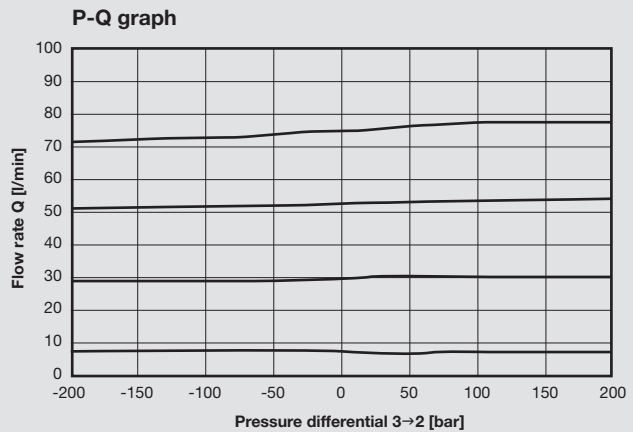



Accumulator Technology 30.000

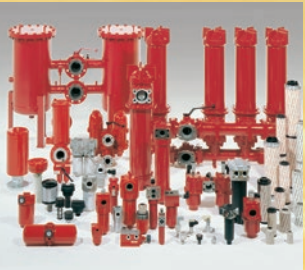

Filter Technology 70.000



Process Technology 77.000



Filter Systems 79.000



Compact Hydraulics 53.000



Accessories 61.000



Electronics 180.000



Cooling Systems 57.000

Global Presence. Local Expertise. www.hydac.com



- HYDAC Headquarters
- HYDAC Companies
- HYDAC Sales and Service Partners



INTERNATIONAL

HYDAC FLUIDTECHNIK
GMBH

Justus-von-Liebig-Straße
66280 Sulzbach/Saar
Germany

Tel.: +49 6897 509-01
Fax: +49 6897 509-577

E-Mail: flutec@hydac.com
Internet: www.hydac.com